

High performance directional valve, ISO size 05
Solenoid controlled, 2-stage
Series WEVDE ...

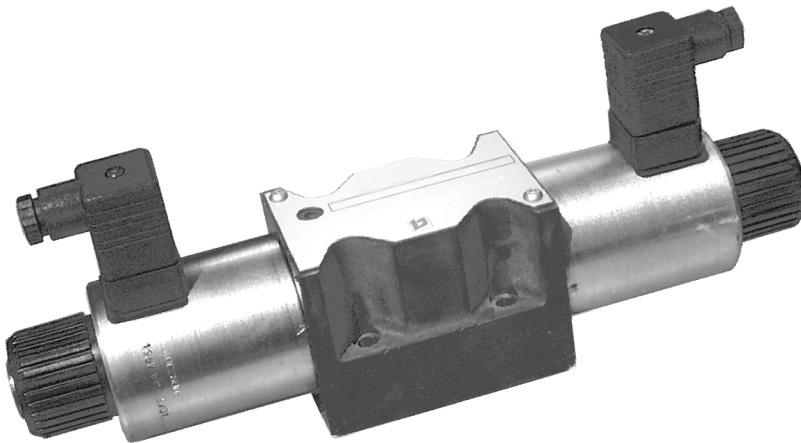

- 315 bar, 160 l/min
- High switching reliability thanks to stage follower spool operation
- Unaffected by:
 - asymmetric flow path
 - long periods under high pressure without switching
 - large pressure drops across the spool lands
 - low supply voltage
- High flow rates
- Good Δp -Q characteristics
- Pressure in P, A and B to 315 bar
- Wet armature design, change coils without opening hydraulic envelope
- With manual override
- Size 05 interface to ISO 4401-05-04

1. Description



Series WEVDE ...-10 high performance spool valves are internally piloted and use the follower spool principle. The main valve components are a cast body, a spring-centered follower spool assembly and wet armature solenoids with pressure-tight core tube and slip-on coil. These valves provide reliable service even under the severest operating conditions such as very high flow rates, high operating pressures, supply voltage drops, long periods without switching, large and sudden

changes in fluid temperature etc. The highly effective spool actuation method combines the advantages of direct acting and two-stage solenoid valves, without incurring the well known disadvantages of either type. The main spool is offset by both the solenoid force and the $P \Rightarrow T$ *) pressure difference inside the valve. The greater the $P \Rightarrow T$ pressure difference, the greater the offsetting force. The spool is returned to the mid-position in the same way, using the $P \Rightarrow T$ pressure difference and without

the need for the usual heavy centering springs. If very low flow rates, or an open circuit condition, result in there being no $P \Rightarrow T$ pressure difference, then the spool actuation reverts to the normal solenoid / centering spring arrangement.

*) The pressure in P must always be equal to, or greater than, that in T and the valve must be connected in the conventional manner i.e. pressure to P, T to tank.

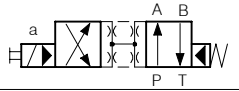
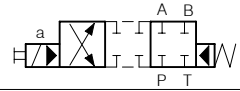
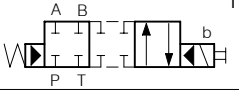
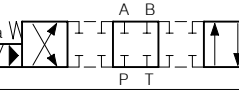
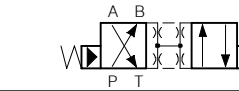
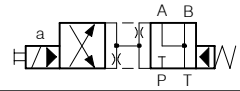
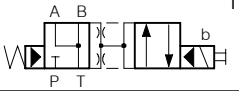
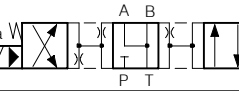
2. Symbols

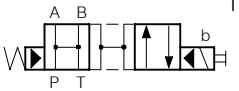
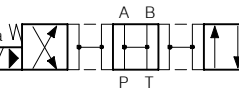
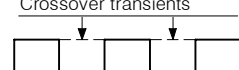
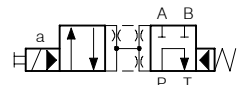
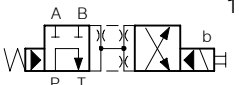
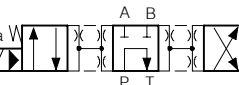
4/2 FUNCTIONS WEVDE-42-A-10  1	4/2 FUNCTIONS WITH 4/3 SPOOLS WEVDE-42-AD-10  7	4/2 FUNCTIONS WITH 4/3 SPOOLS WEVDE-42-BD-10  13	4/3 FUNCTIONS WEVDE-43-D-10  19
WEVDE-42-B-10  2	WEVDE-42-AG-10  8	WEVDE-42-BG-10  14	WEVDE-43-G-10  20
3	WEVDE-42-AH-10  9	WEVDE-42-BH-10  15	WEVDE-43-H-10  21
Crossover transients  4	WEVDE-42-AJ-10  10	WEVDE-42-BJ-10  16	WEVDE-43-J-10  22





3. Characteristics

Type		4/2 and 4/3 solenoid controlled spool valves
Design		combined direct acting and 2-stage
Mounting method		manifold mounting
Size		nominal size 10 mm, size 05 interface to ISO
Mass	kg	4,8 (1 solenoid) 6,3 (2 solenoids)
Mounting attitude		horizontal recommended (vertical mounting makes air bleeding difficult)
Flow direction		see symbols
Operating pressure in P, A und B	bar	max. 315
Operating pressure in T (tank line)	bar	max. 160
Flow rate Qmax	l/min	160
Fluids		Hydraulic oils HL and HLP to DIN 51 524
Fluid temperature range	°C	-25 ... + 80
Ambient temperature	°C	-25 ... + 50
Viscosity range	cSt	10 ... 500, recommended 15 ... 250
Minimum fluid cleanliness		18/14 to ISO 4406 /CETOP RP70H 8 ... 9 to NAS 1638
Magnet type		pressure-tight wet armature design (slip-on coil system)
Standard voltages	VDC	12 / 24 / 98 / 196 for other voltages - please contact BUCHER
Nom. voltage tolerance	%	±10
Nom. power consumption	W	39
Duty cycle	% ED	100
Enclosure protection		IP 65 to DIN 40 050
Electrical connection		3-pin square plug rotatable 4 x 90° to DIN 43 650 / ISO 4400

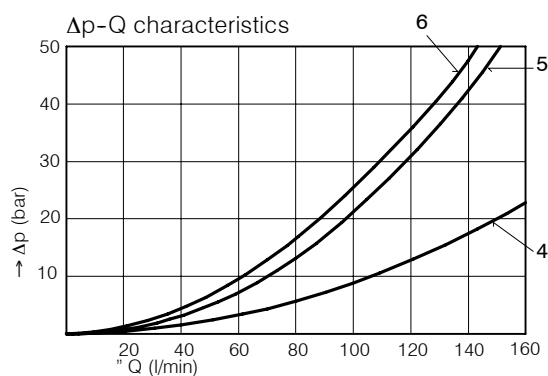
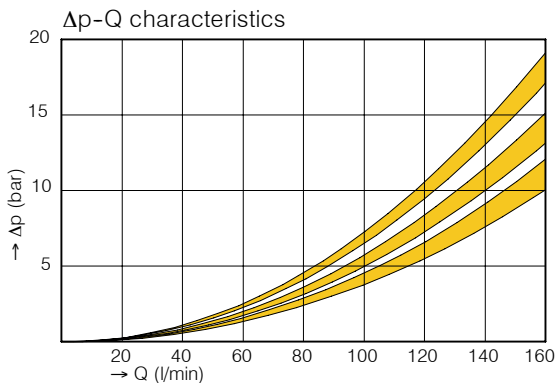
4. Performance graphs

Oil viscosity 33 cSt



	P % A	B % T	P % B	A % T	P % T
 A spool	3	3	2	1	-
 D spool	1	2	1	1	-
 G spool	1	3	1	2	-
 H spool	1	2	2	2	-
 J spool	5	6	5	5	4

Switching times

measured with: 24 VDC solenoid 5% under-voltage, coil at steady-state temperature.

Solenoid ON	45 ... 110 ms
Solenoid OFF	20 ... 50 ms

These are guideline values only, and can be significantly affected by flow rate and pressure. To achieve switching times which are largely unaffected by variations in supply voltage and coil temperature, we recommend our type LRS Power Reducing connector plug. Contact BUCHER for application assistance.

5. Dimensions

DIMENSIONS

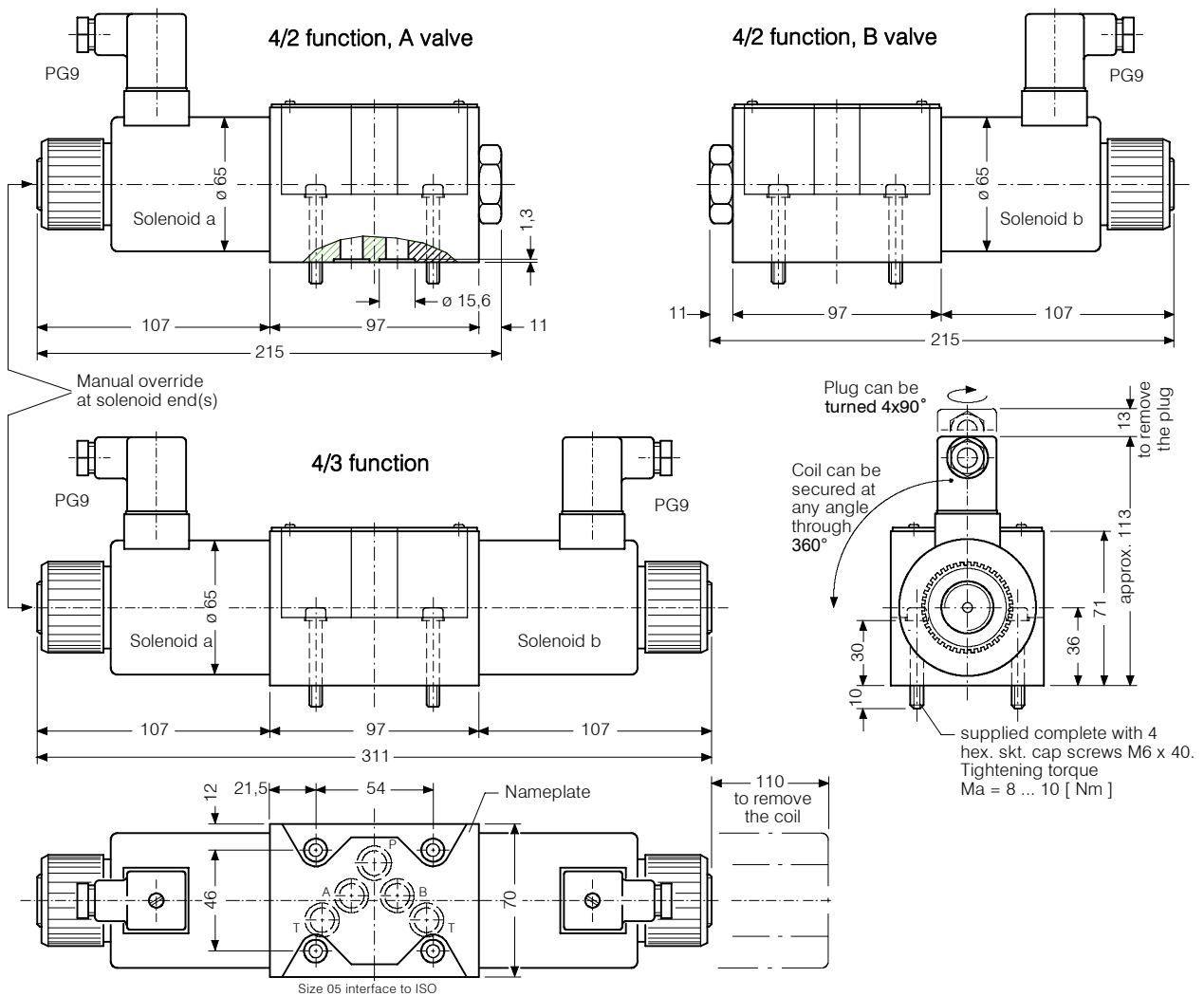

6. Schematic section

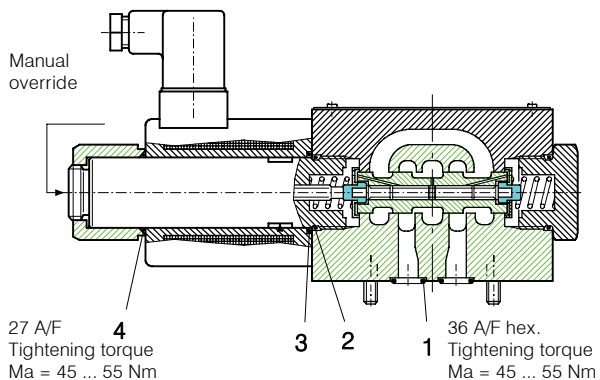

Sealkit no. DS-146, comprising:

Itm.	Qty.	Description	Size
1	5	O-ring no. 014	$\varnothing 12,42 \times 1,78$ N90
2	2	O-ring no. 118	$\varnothing 21,89 \times 2,62$ N90
3	2	O-ring	$\varnothing 30,00 \times 2,00$ N70
4	2	O-ring	$\varnothing 30,00 \times 2,00$ N70

7. Installation and servicing

All installation and servicing must be carried out with care, and by qualified personnel only. When servicing valves (cleaning, changing seals, etc.) note the following: 'A' (and 'B') spools must not be reversed, or the function $P \Rightarrow A / B \Rightarrow T$ will become $P \Rightarrow B / A \Rightarrow T$ (and

vice versa). All other spools are symmetrical but should always be reassembled with their original orientation, in any case. When changing seals, the new seals should be thoroughly oiled or greased before fitting them to the valve. Use the correct tightening torque when

fitting Spring cap, DC and Core tube. At installation, be sure to mount the valve with its hydraulic ports mating with those of the manifold block or subplate and, finally, use the correct tightening torque for the 4 x M6 mounting screws.

8. Model code key

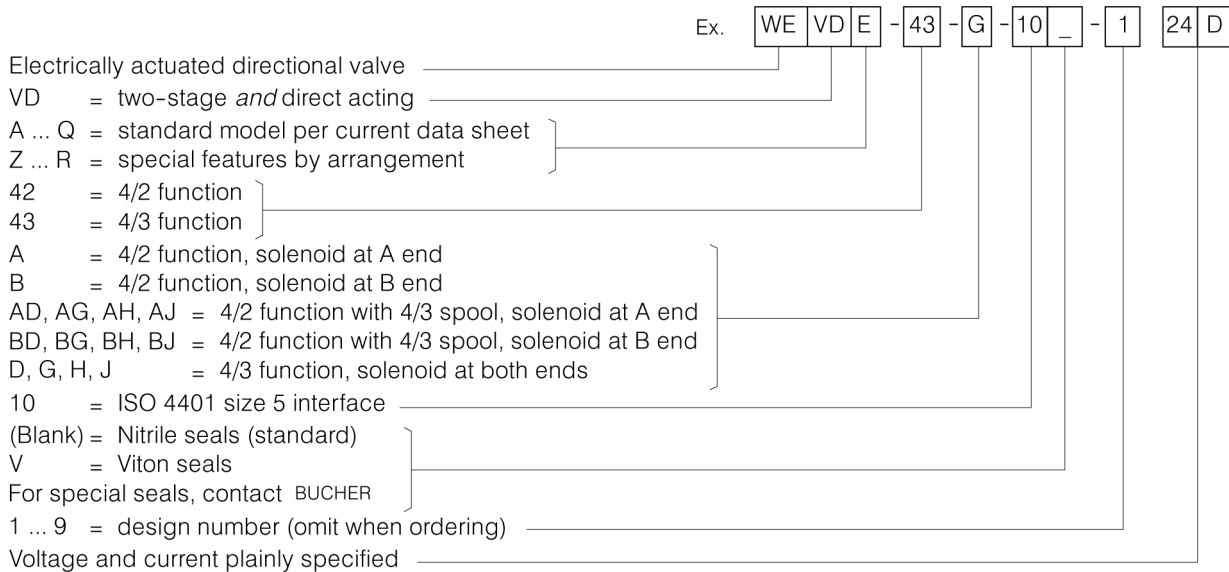

9. Related data sheets

400-P-010101-EN	Table of interface equivalents
400-P-050101-EN	Size 05 interface to ISO 4401-05-04
400-P-515101-EN	LRSA DIN plug
400-P-102100-EN	High Performance Spool Valves (Principle/Overview)

info.ch@bucherhydraulics.com

www.bucherhydraulics.com

© 2023 by Bucher Hydraulics AG Frutigen, CH-3714 Frutigen

All rights reserved.

Data is provided for the purpose of product description only, and must not be construed as warranted characteristics in the legal sense. The information does not relieve users from the duty of conducting their own evaluations and tests. Because the products are subject to continual improvement, we reserve the right to amend the product specifications contained in this catalogue.