

Proportional Throttle Cartridges, Size 16

$Q_{\max} = 250 \text{ l/min}$, $p_{\max} = 250 \text{ bar}$, $Q_{N \max} = 140 \text{ l/min}$ at $\Delta p 10 \text{ bar}$
 Two-Stage, with Seat-Valve Shut-Off
 Series MVRPSBB-RG...



- Normally closed
- Seat-valve shut-off from 2 → 1
- Compact construction for cavity type ER to ISO 7789-33-01-0-07
- 3 nominal flow ranges
- More reliable operation over the whole pressure and flow range (high pressure differences)
- Low headloss
- All exposed parts with zinc-nickel plating
- High pressure wet-armature solenoids
- The slip-on coil can be rotated, and it can be replaced without opening the hydraulic envelope
- Various plug-connector systems and voltages are available
- Can be fitted in a line-mounting body

1 Description

Series MVRPSBB... two-stage proportional throttle cartridges are size 16, high performance screw-in valves with an M33 x 2 mounting thread. Both the main and pilot stages are designed on the poppet/seat principle and the 2 → 1 flow path is therefore virtually leak-free. With these proportional throttle cartridges, the flow rate from 2 → 1 is dependent on the control current, and it can be varied continuously and set at any desired level. The throttle cartridges are available in 3 nominal flow ranges. When used with a pressure compensator, these cartridges are particularly suitable for precise and load-compensated lifting and lowering move-

ments, but they can also be used on their own for reliable operation in mobile and industrial applications with large pressure differences. All external parts of the cartridge are zinc-nickel plated to DIN 50 979 and are thus suitable for use in the harshest operating environments. The slip-on coils can be replaced without opening the hydraulic envelope and can be positioned at any angle through 360°. If you intend to manufacture your own cavities or are designing a line-mounting installation, please refer to the section "Related data sheets".

2 Symbol

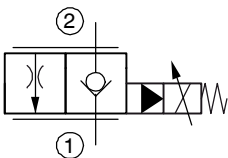

3 Technical data

General characteristics	Description, value, unit
Designation	proportional-throttle cartridge
Design	seat-valve shut-off, two stage
Mounting method	screw-in cartridge M33 x 2
Tightening torque	150 Nm ± 10 %
Size	nominal size 16 mm, cavity type ER
Weight	0.95 kg
Mounting attitude	unrestricted (preferably vertical, coil down)

General characteristics	Description, value, unit
Ambient temperature range	-25 °C ... +60 °C
MTTF _D values	150 years, see data sheet 400-P-010101-en

Hydraulic characteristics	Description, value, unit
Maximum operating pressure	250 bar
Maximum flow rate	250 l/min
Nominal flow rate	60, 90, 140 l/min at $\Delta p = 10$ bar
	< 0,2 cm ³ /min (max. 5 drops/min) with oil viscosity 33 mm ² /s (cSt)
Flow direction	2 → 1 throttle function, see symbols 1 → 2 free flow
Hydraulic fluid	HL and HLP mineral oil to DIN 51 524; for other fluids, please contact BUCHER
Hydraulic fluid temperature range	-25 °C ... +70 °C
Viscosity range	15...380 mm ² /s (cSt), recommended 20...130 mm ² /s (cSt)
Minimum fluid cleanliness Cleanliness class to ISO 4406 : 1999	class 18/16/13

Electrical characteristics	Description, value, unit
Supply voltage	12 V DC, 24 V DC
Control current	12 V = 0...2300 mA, 24 V = 0...1160 mA
Coil resistance R - cold value at 20 °C - max. warm value	12 V = 2.64 Ω / 24 V = 10.10 Ω 12 V = 4.00 Ω / 24 V = 15.20 Ω
Recommended PWM frequency (dither)	200 Hz
Hysteresis with PWM	2...4 % I _N
Reversal error with PWM	2...4 % I _N
Sensitivity with PWM	< 1 % I _N
Reproducibility with PWM	< 2 % p _N
Switching time	see performance graph
Relative duty cycle	100 %
Protection class to ISO 20 653 / EN 60 529	IP 65 / IP 67 / IP 69K, see "Ordering code" (with appropriate mating connector and proper fitting and sealing)
Electrical connection	DIN EN 175301-803, 3-pin 2 P+E (standard) for other connectors, see "Ordering code"

4 Performance graphs measured with oil viscosity 33 mm²/s (cSt)

$Q = f(\Delta p; I)$ Flow rate adjustment characteristic [„140“]

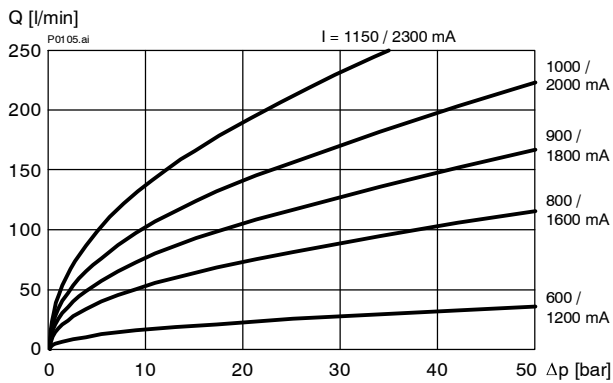

$Q = f(I; \Delta p)$ Flow rate adjustment characteristic [„140“]

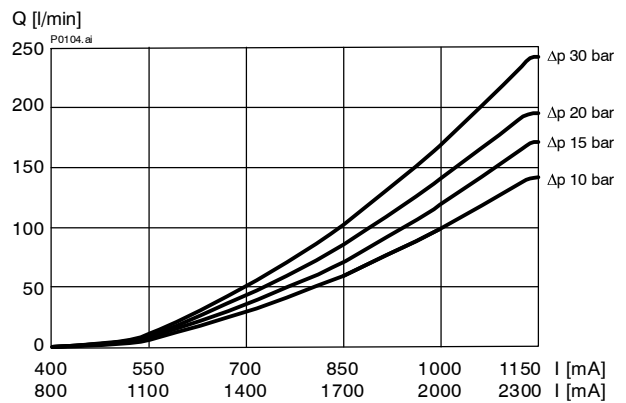

$Q = f(\Delta p; I)$ Flow rate adjustment characteristic [„90“]

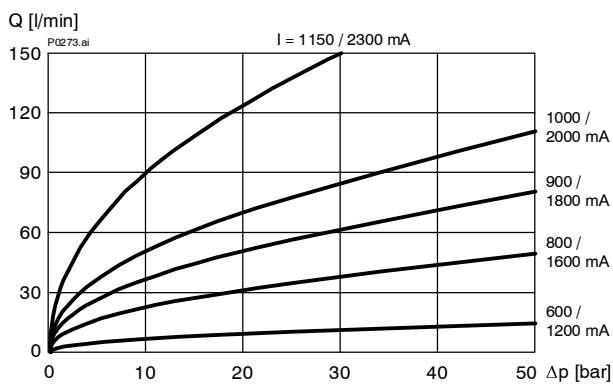

$Q = f(I; \Delta p)$ Flow rate adjustment characteristic [„90“]

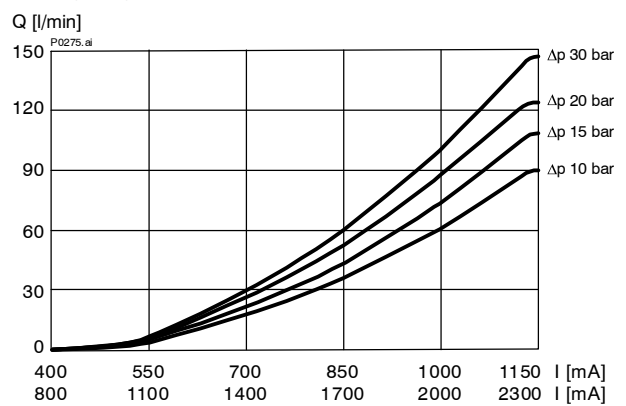

$Q = f(\Delta p; I)$ Flow rate adjustment characteristic [„60“]

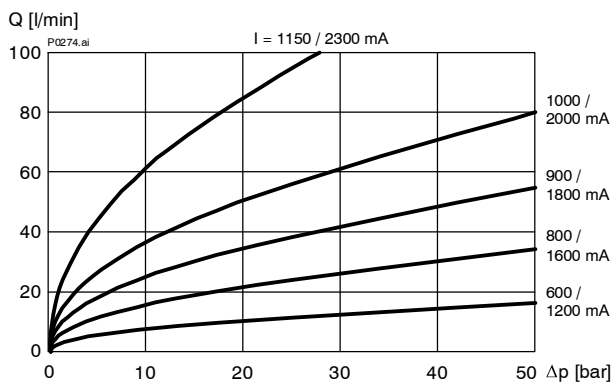

$Q = f(I; \Delta p)$ Flow rate adjustment characteristic [„60“]

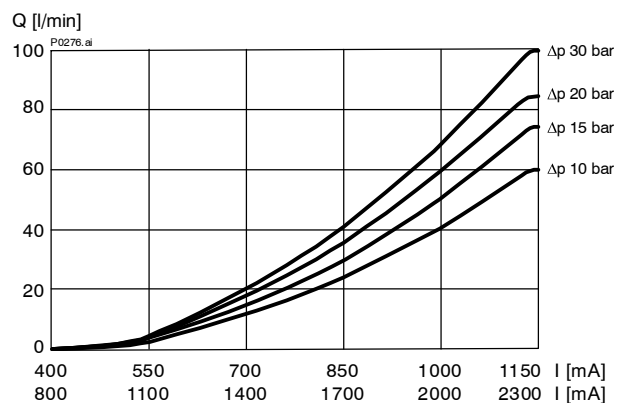

$\Delta p = f(Q)$ Pressure drop - Flow rate characteristic [2 → 1]

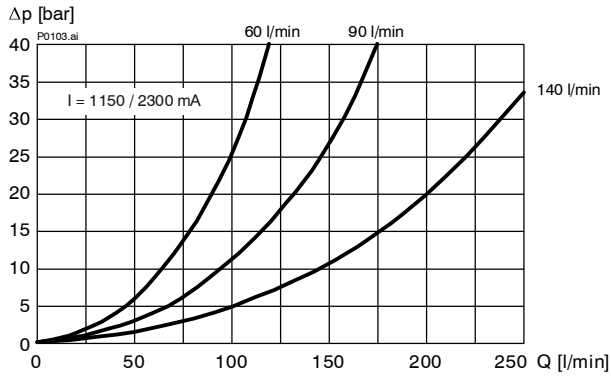

$\Delta p = f(Q)$ Pressure drop - Flow rate characteristic [1 → 2]

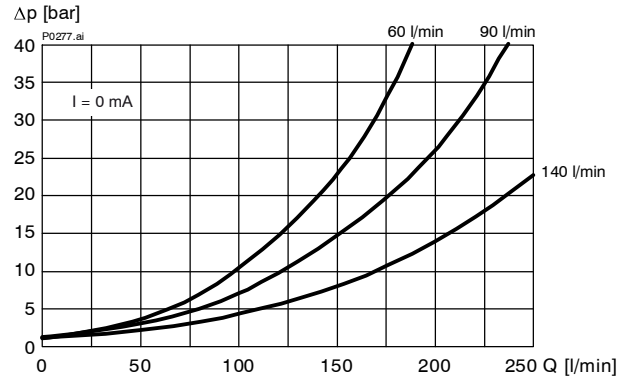

Attention:

where there are large pressure differences in the flow direction 1 → 2, the main stage poppet will become damaged.

$t = f(I; \Delta p)$ Switching time characteristic Opening at $\Delta p = 10 \dots 50$ bar

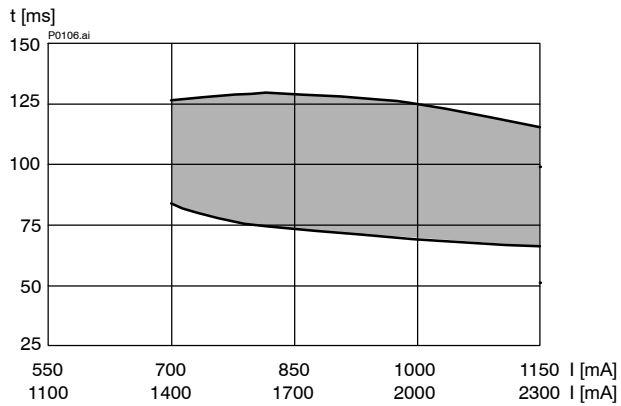

$t = f(I; \Delta p)$ Switching time characteristic Closing at $\Delta p = 10 \dots 50$ bar

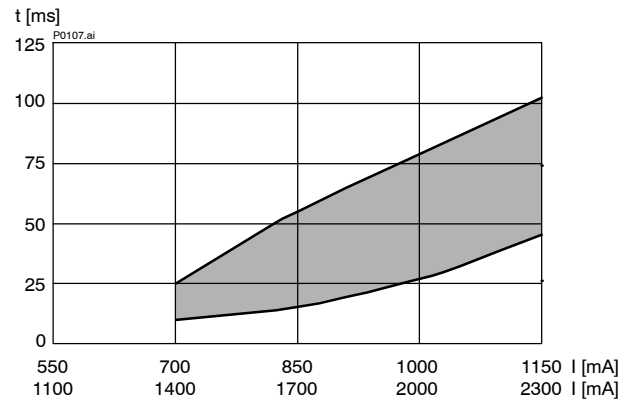

5 Dimensions & sectional view

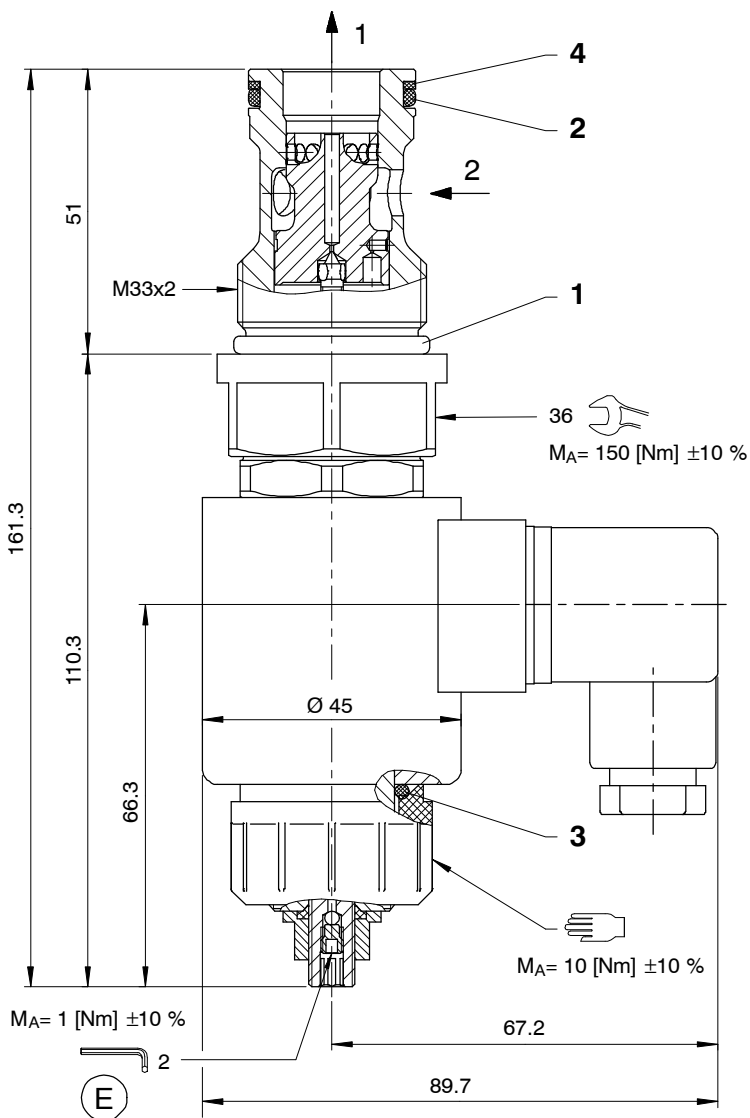

6 Application examples

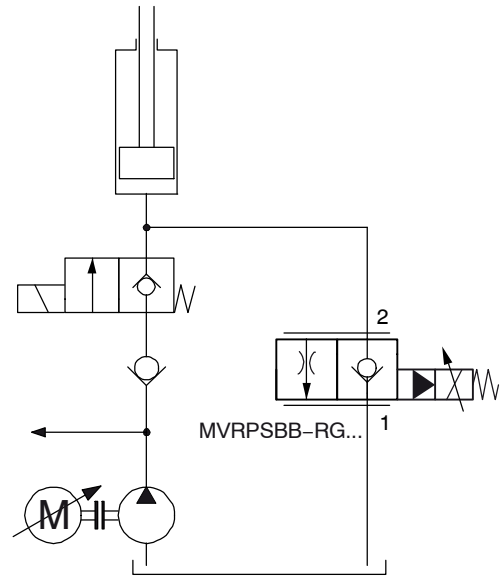

7 Installation information



IMPORTANT!

To achieve the maximum performance rating, fit the solenoid coil as shown (with the plug pins at the bottom) and install the valve in a steel body. When fitting the cartridges, note the mounting attitude (preferably vertical, with coil down → automatic air bleed) and use the specified tightening torque. No adjustments are necessary, since the cartridges are set in the factory.



ATTENTION!

Only qualified personnel with mechanical skills may carry out any maintenance work. Generally, the only work that should ever be undertaken is to check, and possibly replace, the seals. When changing seals, oil or grease the new seals thoroughly before fitting them.

Seal kit NBR no. DS-377-N ¹⁾

Item	Qty.	Description
1	1	O-ring no. 123 $\varnothing 29.82 \times 2.62$ N90
2	1	O-ring no. 119 $\varnothing 23.47 \times 2.62$ N90
3	1	O-ring no. 118 $\varnothing 21.89 \times 2.62$ FKM
4	1	Backup ring $\varnothing 22.50 \times 2.00 \times 1.40$ FI0751



IMPORTANT!

¹⁾ Seal kit with FKM (Viton) seals, no. DS-377-V

8 Ordering code

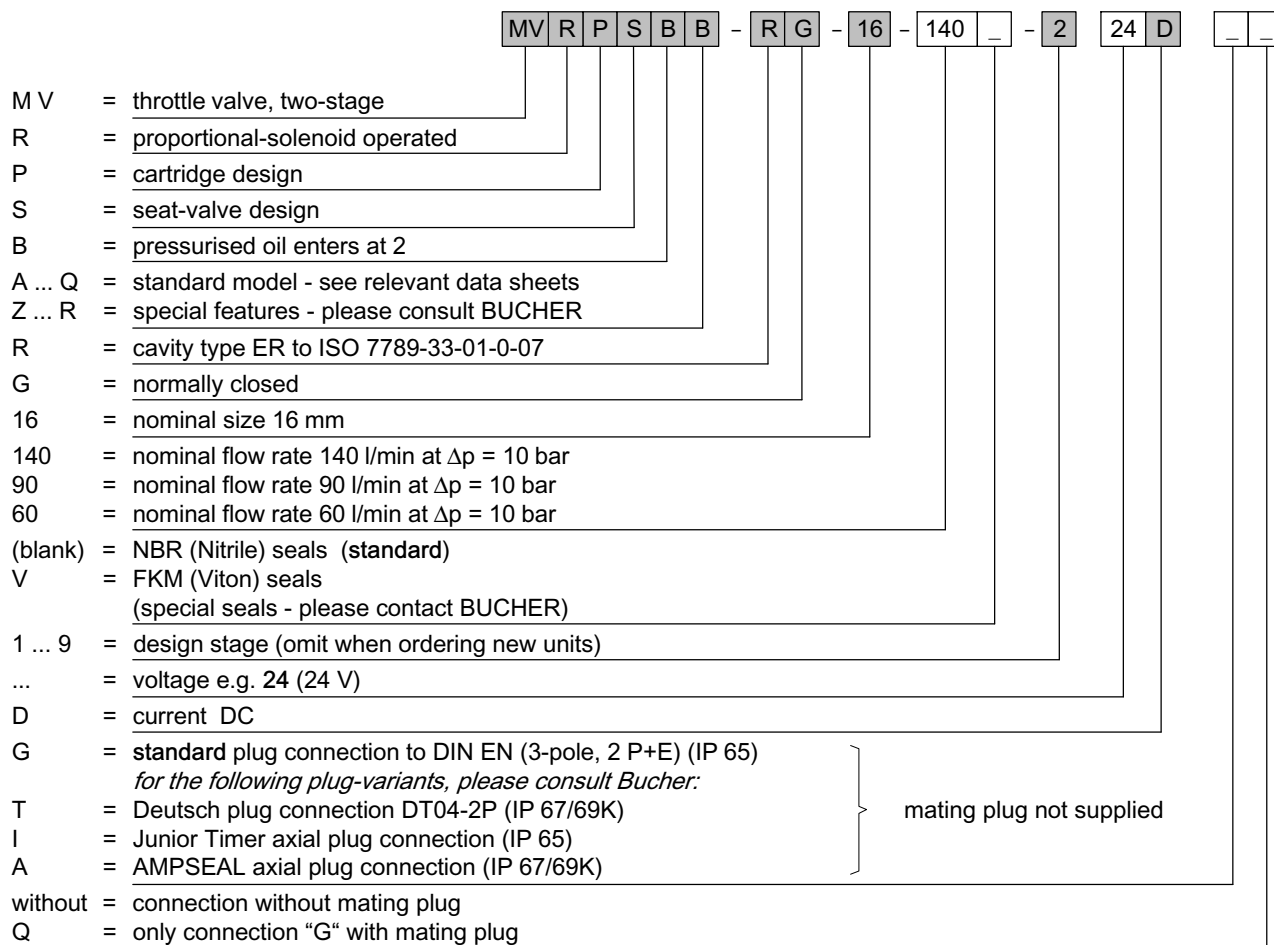

9 Related data sheets

Reference	(Old no.)	Description
400-P-040011	(i-32)	The form-tool hire programme
400-P-080131		Cavity type ER to ISO 7789-33-01-0-07
400-P-120130		Coils for Solenoid Valves, Series D45/22...
400-P-510101		Amplifier unit for proportional valves (1-channel) PBS - 3A
400-P-750121		Line-mounting body, type GERA (G 3/4")
400-P-010101		MTTF _D values for hydraulic valves

info.ch@bucherhydraulics.com

www.bucherhydraulics.com

© 2020 by Bucher Hydraulics AG Frutigen, CH-3714 Frutigen

All rights reserved.

Data is provided for the purpose of product description only, and must not be construed as warranted characteristics in the legal sense. The information does not relieve users from the duty of conducting their own evaluations and tests. Because the products are subject to continual improvement, we reserve the right to amend the product specifications contained in this catalogue.

Classification: 430.310.325.305.330.310