

Prop. Pressure-Reducing/Relieving Cartridge, Size SAE 08

$Q_{\max} = 7.0 \text{ gpm [26 l/min]}$, $p_{\max} = 3400 \text{ psi [240 bar]}$
Seated pilot, spool-type main stage
Series EPRT-08...

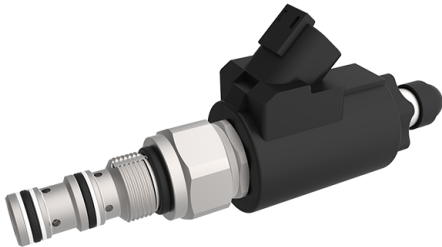

- Compact construction for cavity types: C0830 and AM - 3/4-16 UNF
- Operated by a proportional solenoid
- 3 pressure ranges available
- Full-flow secondary pressure relief
- Internal pilot-oil drain
- Pilot stage protected from dirt by gap filter
- Excellent stability over the whole pressure and flow range
- Manual override
- All exposed parts with zinc-nickel plating
- High pressure wet-armature solenoids
- The slip-on coil can be rotated, and it can be replaced without opening the hydraulic envelope
- Various plug-connector systems and voltages are available
- Can be fitted in a line-mounting body

1 Description

Series EPRT-08... proportional pressure-reducing / relieving valves are size SAE 08 / NG 5, high performance screw-in cartridges with a 3/4-16 UNF mounting thread. Using the leak-free seat-type pilot cartridge, the secondary pressure in port 1 is dependent on the electrical control signal and it can be continuously varied and set at any desired level. In control mode, the connection 2 → 1 opens until the pressure in port 1 reaches the preset level. If the pressure rises above the preset level, the control spool opens the 1 → 3 connection until balance is attained. These pressure-reducing / relieving cartridges function as full-flow pressure relief valves from port 1 → 3 as soon as the reduced pressure rises above the valve pressure setting. A high degree

of functional stability is reached even if the back pressure in the tank line fluctuates. Three pressure ranges are available in order to obtain precise pressure settings over the whole pressure range. These pressure-reducing / relieving cartridges are predominantly used in mobile and industrial applications for reducing a system pressure. All external parts of the cartridge are zinc-nickel plated to DIN 50 979 and are thus suitable for use in the harshest operating environments. The slip-on coils can be replaced without opening the hydraulic envelope and can be positioned at any angle through 360°. If you intend to manufacture your own cavities or are designing a line-mounting installation, please refer to the section "Related data sheets".

2 Symbol

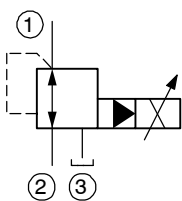

3 Technical data

General characteristics	Description, value, unit
Designation	proportional pressure-reducing / relieving cartridge
Design	seated pilot, spool-type main stage
Mounting method	screw-in cartridge 3/4-16 UNF

General characteristics	Description, value, unit
Tightening torque	30 ft-lbs ± 10 % [40 Nm ± 10 %]
Size	size SAE 08 for cavity type C0830 NG 5 for cavity type AM
Weight	0.93 lbs [0.42 kg]
Mounting attitude	unrestricted (preferably vertical, coil down)
Ambient temperature range	-13 °F ... +122 °F [-25 °C ... +50 °C]

Hydraulic characteristics	Description, value, unit
Maximum operating pressure - ports 1, 2 - port 3	3400 psi [240 bar] 3000 psi [210 bar] ¹⁾
Maximum flow rate	7 gpm [26 l/min]
Nominal pressure ranges	1500, 2500, 3000 psi [100, 175, 210 bar] <small>For further pressure ranges, please contact BUCHER</small>
Pilot-oil consumption	0.05... 0.08 gpm [0,2 ... 0,3 l/min]
Flow direction	2 → 1 pressure reducing 1 → 3 pressure relieving
Hydraulic fluid	HL and HLP mineral oil to DIN 51 524; for other fluids, please contact BUCHER
Hydraulic fluid temperature range	-13 °F ... +158 °F [-25 °C ... +70 °C]
Viscosity range	15...380 mm ² /s (cSt), recommended 20...130 mm ² /s (cSt)
Minimum fluid cleanliness Cleanliness class to ISO 4406 : 1999	class 18/16/13



ATTENTION!

¹⁾ To prevent any pressure surges, port 3 must be routed to tank with the least possible back-pressure.

Electrical characteristics	Description, value, unit
Supply voltage	12 V DC, 24 V DC
Supply voltage tolerance	± 10 %
Control current	12 V = 0...1400 mA, 24 V = 0...750 mA
Power consumption at max. control current	max. 19 W
Coil resistance R - cold value at 20 °C - max. warm value	12 V = 5.8 Ω / 24 V = 21 Ω 12 V = 8.6 Ω / 24 V = 32 Ω
Recommended PWM frequency (dither)	200 Hz
Hysteresis with PWM	2...4 % I _N
Reversal error with PWM	1...3 % I _N
Sensitivity with PWM	≤ 1 % I _N
Reproducibility with PWM	< 2 % p _N

Electrical characteristics	Description, value, unit
Switching time	<i>Pressure-reducing function:</i> 38 ... 45 ms (solenoid ON) 8 ... 12 ms (solenoid OFF) <i>Pressure-relief function:</i> 41 ... 51 ms (solenoid ON) 6 ... 12 ms (solenoid OFF) The switching times are strongly influenced by flow rate, pressure, viscosity and the dwell period under pressure.
Relative duty cycle	100 %
Protection class to ISO 20 653 / EN 60 529	IP 65 / IP 67 / IP 69K, see "Ordering code" (with appropriate mating connector and proper fitting and sealing)
Electrical connection	DIN EN 175301-803, 3-pin 2 P+E (standard) for other connectors, see "Ordering code"

4 Performance graphs measured with oil viscosity 33 mm²/s (cSt)

$p = f(I)$ Pressure adjustment characteristic

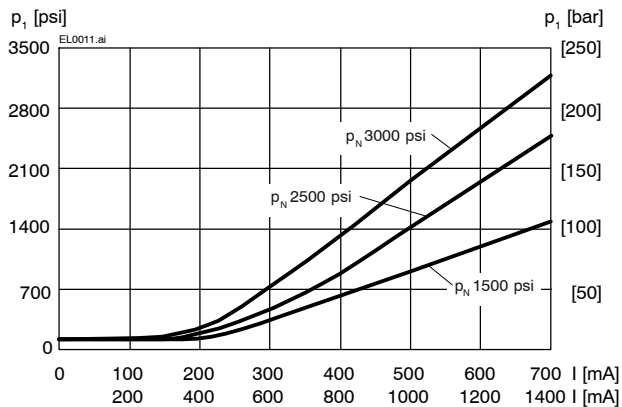

$\rho = f(Q)$ Pressure - Flow rate characteristic [$\rho_N = 3000 \text{ psi}$]

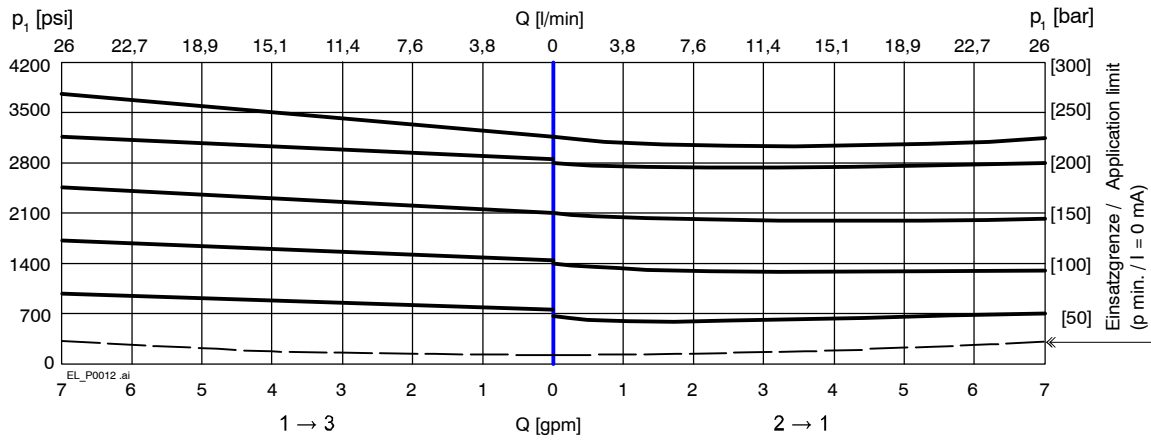

$\rho = f(Q)$ Pressure - Flow rate characteristic [$\rho_N = 2500 \text{ psi}$]

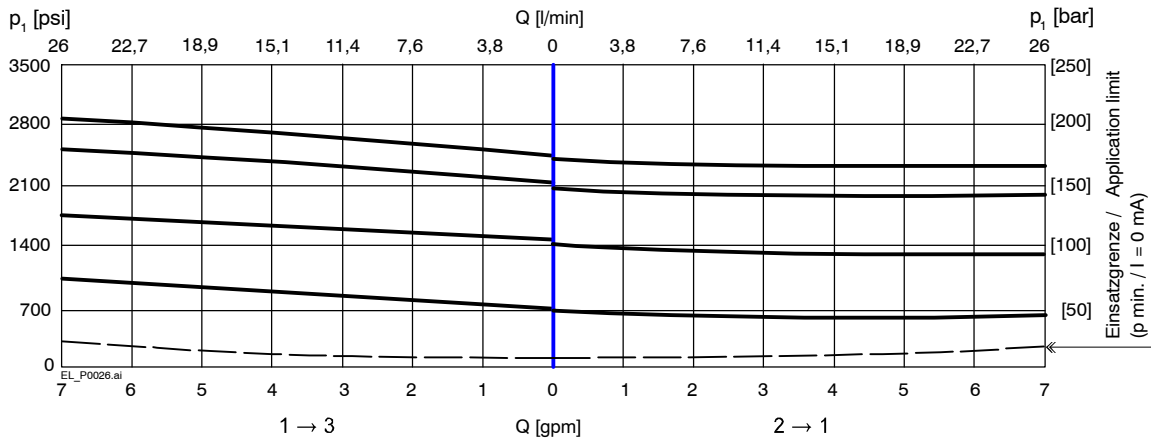

$\rho = f(Q)$ Pressure - Flow rate characteristic [$\rho_N = 1500 \text{ psi}$]

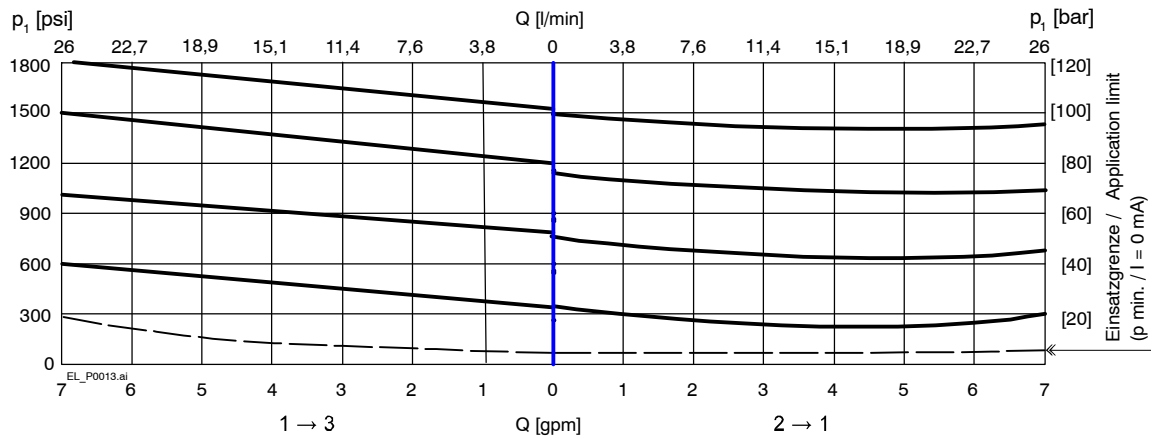

5 Dimensions & sectional view

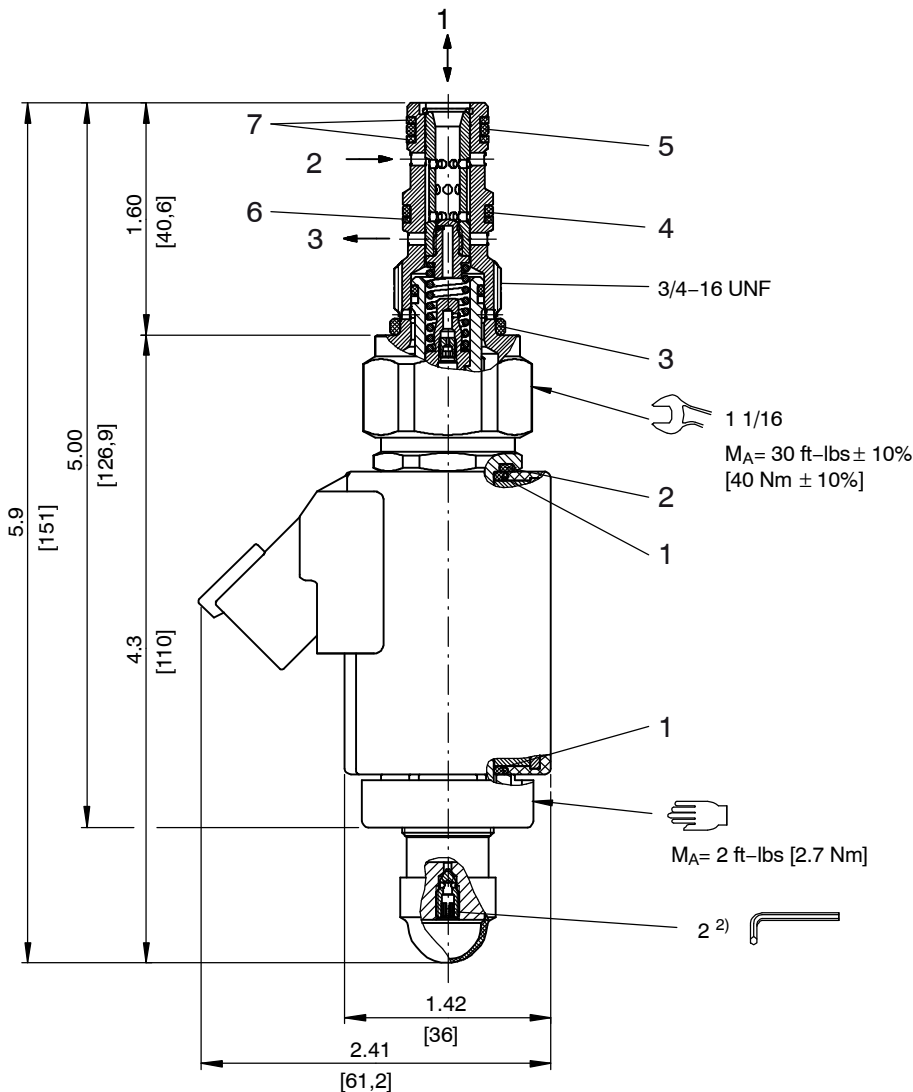

6 Installation information



IMPORTANT!

To achieve the proportional pressure-reducing cartridge's maximum performance rating, fit the solenoid coil as shown (with the plug pins at the bottom). When fitting the cartridges, note the mounting attitude (preferably vertical, with coil down → automatic air bleed) and use the specified tightening torque. No adjustments are necessary, since the cartridges are set in the factory.



ATTENTION!

Only qualified personnel with mechanical skills may carry out any maintenance work. Generally, the only work that should ever be undertaken is to check, and possibly replace, the seals. When changing seals, oil or grease the new seals thoroughly before fitting them.

Seal kit NBR no. SKN-0832-12-S1¹⁾

Item	Qty.	Description			
1	2	O-ring	∅ 16,00 x 2,00	FKM	mm
2	1	O-ring	∅ 18,00 x 2,00	FKM	mm
3	1	O-ring no. 908	∅ 0,644 x 0,087	N70	Inch
4	1	O-ring no. 014	∅ 0,489 x 0,070	N70	Inch
5	2	O-ring no. 013	∅ 0,426 x 0,070	N70	Inch
6	1	Backup ring FI0751	∅ 0,421 x 0,057 x 0,039		Inch
7	2	Backup ring FI0751	∅ 0,370 x 0,057 x 0,039		Inch



IMPORTANT!

- 1) Seal kit with FKM (Viton) seals, no. SKV-0832-12-S1
- 2) vent screw to vent valve when mounted coil up screw torqued hand tight.

7 Ordering code

Ex. **EPRT** - **08** - **N** - **30** - **0** - **24** **D** -

EPRT	=	prop. pressure-reducing / relieving valve, two stage	
08	=	nominal size SAE 08	
N	=	NBR (Nitrile) seals (standard)	
V	=	FKM (Viton) seals (special seals - please contact BUCHER)	
30	=	Pressure option 3000 psi	
25	=	Pressure option 2500 psi	
15	=	Pressure option 1500 psi	
0	=	cartridge only	
02BA	=	line-mounting body G1/4 BSPP	aluminum
02BS	=	line-mounting body G1/4 BSPP	steel
03BA	=	line-mounting body G3/8 BSPP	aluminum
03BS	=	line-mounting body G3/8 BSPP	steel
06TA	=	line-mounting body SAE-6	aluminum
06TS	=	line-mounting body SAE-6	steel
...	=	voltage e.g. 24 (24 V)	
D	=	current DC	
(blank)	=	DIN EN 175301-803 connection with mating plug (standard, IP 65)	
M100	=	DIN EN 175301-803 connection without mating plug	
C	=	Kostal plug connection (IP 65)	} mating plug not supplied
JT	=	Junior Timer radial plug connection (with protection diode, IP65)	
IT	=	Junior Timer axial plug connection (with protection diode, IP65)	
D	=	Deutsch plug connection 45° DT04-2P (IP67/69K)	
DT	=	Deutsch plug connection 45° DT04-2P (with protection diode, IP67/69K)	
S	=	AMP Superseal 1.5 (IP67) / Metri-Pack 150 (IP65) plug connection	
F	=	flying leads (500 mm)	

on request

8 Related data sheets

Reference	(Old no.)	Description
520-P-000050		The form-tool loan program
520-P-000310	(0-031.0)	Cavity type C0830
400-P-040181		Cavity type AM
400-P-120110	(W-2.141)	Coils for screw-in cartridge valves
400-P-510101		Amplifier unit for proportional valves (1-channel) PBS - 3A
400-P-511101	(P-3)	Amplifier card, 1-channel for valves with one solenoid, type SAN-535...
520-P-000311	(0-031.1)	Line-mounting body, 8 Series -3-way
400-P-720111	(G-4.20)	Line-mounting body, type GAMA (G 3/8")

info.el@bucherhydraulics.com

www.bucherhydraulics.com/commoncavity

© 2019 by Bucher Hydraulics, Inc., 2545 Northwest Parkway, Elgin, Illinois 60124, USA

All rights reserved.

Data is provided for the purpose of product description only, and must not be construed as warranted characteristics in the legal sense. The information does not relieve users from the duty of conducting their own evaluations and tests. Because the products are subject to continual improvement, we reserve the right to amend the product specifications contained in this catalogue.

Classification: 430.300.305.305.320.310