

3-Way Pressure-Reducing Cartridge, Size 10

$Q_{\max} = 70 \text{ l/min}$, $p_{\max} = 315 \text{ bar}$
 Spool-type design, direct acting, with manual adjustment
 Series DDRA-7L...



- Compact construction for cavity type DL to ISO 7789-27-04-0-07
- 5 pressure ranges available
- Full-flow secondary pressure relief
- Excellent stability over the whole pressure and flow range
- All exposed parts with zinc-nickel plating
- Can be fitted in a line-mounting body
- Can be fitted in sandwich bodies

1 Description

Series DDRA-7L... screw-in cartridges are size 10, high performance 3-way pressure-reducing valves with an M27 x 2 mounting thread. They are direct acting and have a spool-type design. The straightforward design delivers an outstanding price/performance ratio and good pressure/flow ratings. The valves control the required secondary pressure in port 1 to the value set with the pressure adjustment, and independently of the inlet pressure in port 2. In control mode, the connection 2 → 1 opens until the pressure in port 1 reaches the preset level. If the pressure rises above the preset level, the control spool opens the 1 → 3 connection until balance is restored. These 3-way pres-

sure-reducing cartridges function as full-flow pressure relief valves from port 1 → 3 as soon as the reduced pressure rises above the valve pressure setting. Five spring ranges are available in order to obtain precise pressure settings over the whole of the required pressure range. These 3-way pressure-reducing cartridges are predominantly used in mobile and industrial applications for reducing a system pressure. All external parts of the cartridge are zinc-nickel plated to DIN 50 979 and are thus suitable for use in the harshest operating environments. If you intend to manufacture your own cavities or are designing a line-mounting installation, please refer to the section "Related data sheets".

2 Symbol

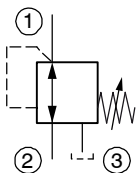

3 Technical data

General characteristics	Description, value, unit
Designation	3-way pressure-reducing cartridge
Design	Spool-type design, direct acting, with manual adjustment
Mounting method	screw-in cartridge M27 x 2
Tightening torque	80 Nm ± 10 %
Size	nominal size 10, cavity type DL
Weight	0.60 kg
Mounting attitude	unrestricted
Ambient temperature range	-25 °C ... +80 °C

Hydraulic characteristics	Description, value, unit
Maximum operating pressure	315 bar
Maximum flow rate	70 l/min
Nominal pressure ranges	30 bar, 60 bar, 100 bar, 160 bar, 250 bar
Pressure adjustment range	1 turn \cong 34 bar = pressure range 250 bar 1 turn \cong 24 bar = pressure range 160 bar 1 turn \cong 14 bar = pressure range 100 bar 1 turn \cong 8 bar = pressure range 60 bar 1 turn \cong 5 bar = pressure range 30 bar
Flow direction	see symbol
Hydraulic fluid	HL and HLP mineral oil to DIN 51 524; for other fluids, please contact BUCHER
Hydraulic fluid temperature range	-25 °C ... +80 °C
Viscosity range	10...650 mm ² /s (cSt), recommended 15...250 mm ² /s (cSt)
Minimum fluid cleanliness Cleanliness class to ISO 4406 : 1999	class 20/18/15

4 Performance graphs

measured with oil viscosity 33 mm²/s (cSt)

$p = f(Q)$ Pressure - Flow rate characteristic [$p_N = 30$ bar]

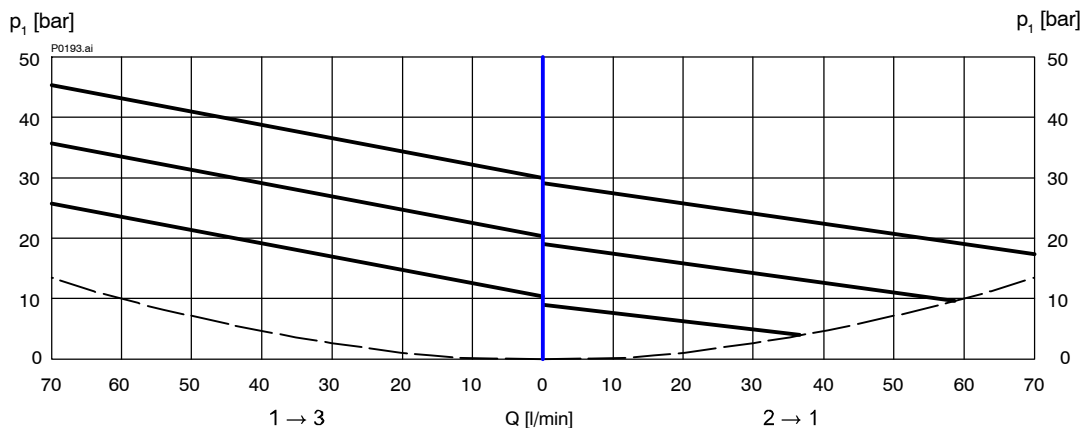

$p = f(Q)$ Pressure - Flow rate characteristic [$p_N = 60$ bar]

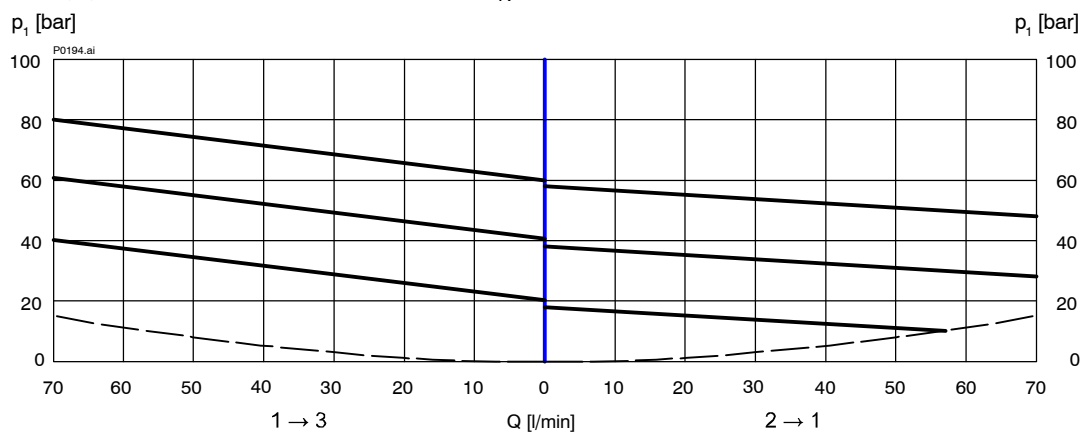

$p = f(Q)$ Pressure - Flow rate characteristic [$p_N = 100 \text{ bar}$]

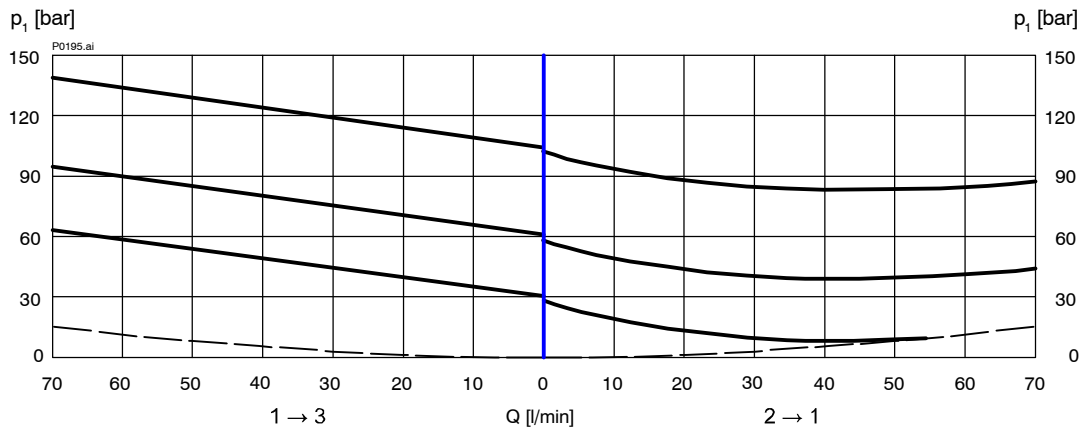

$p = f(Q)$ Pressure - Flow rate characteristic [$p_N = 160 \text{ bar}$]

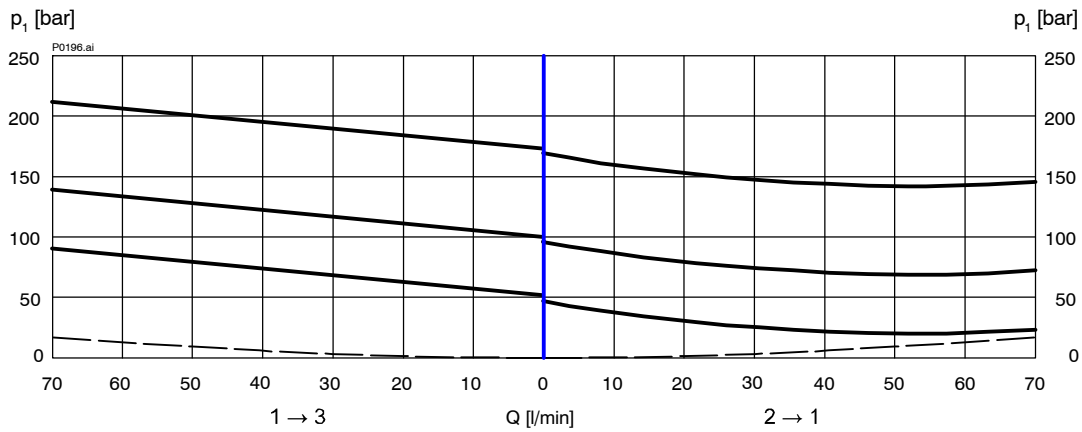

$p = f(Q)$ Pressure - Flow rate characteristic [$p_N = 250 \text{ bar}$]

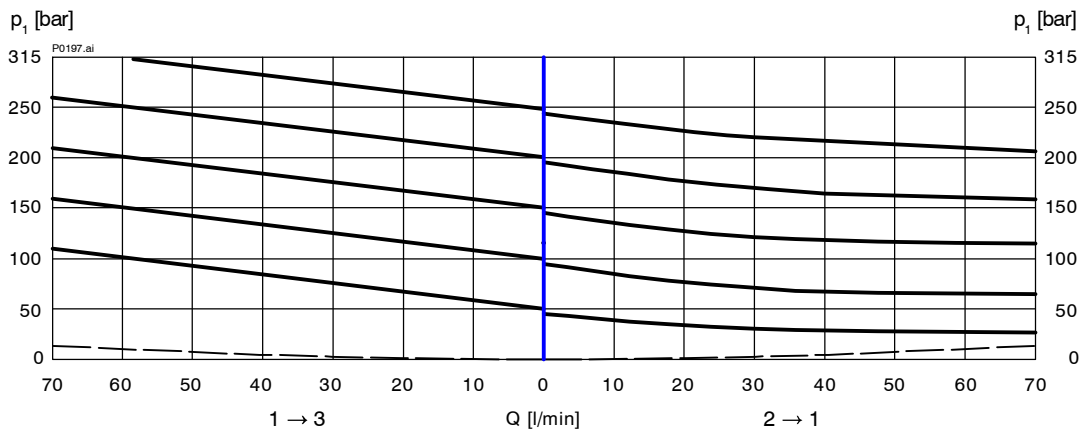

$Q_L = f(p)$ Leakage flow rate characteristic

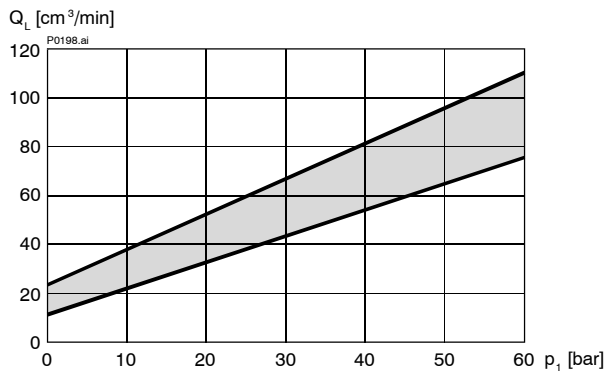

DDRA-7L-10-03...
DDRA-7L-10-06...

$Q_L = f(p)$ Leakage flow rate characteristic

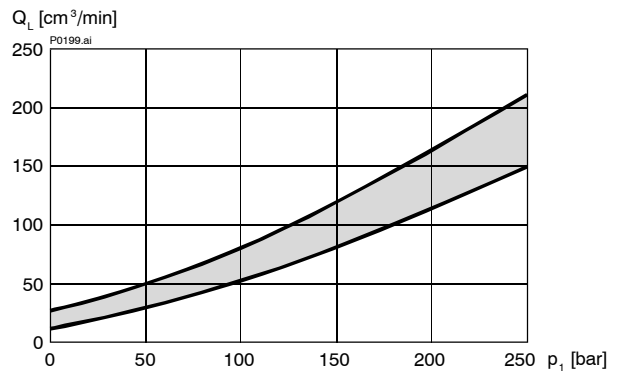

DDRA-7L-10-10...
DDRA-7L-10-16...
DDRA-7L-10-25...

5 Dimensions & sectional view

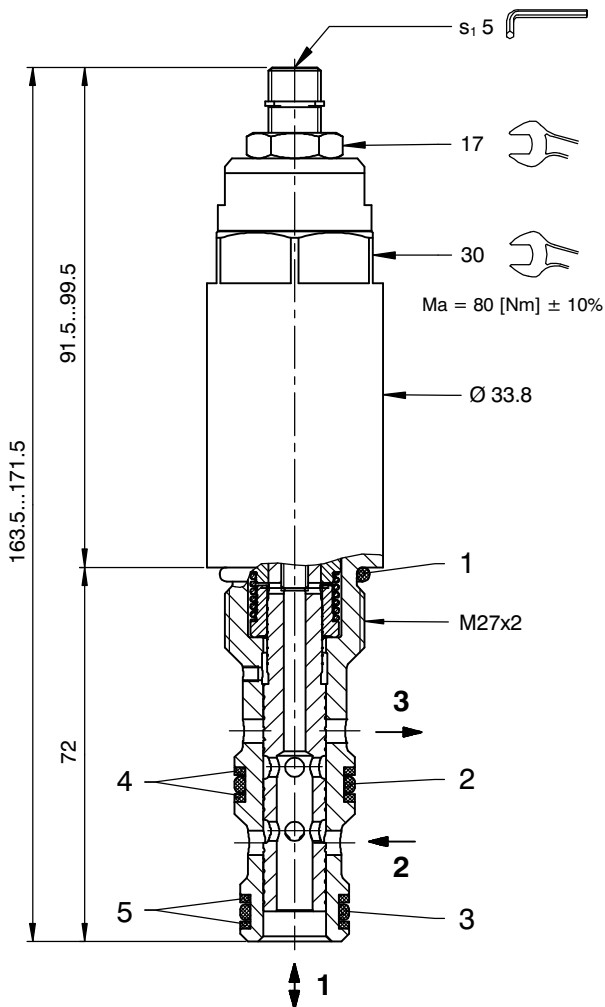

6 Installation information



IMPORTANT!

When fitting the cartridges, use the specified tightening torque. Set the required pressure with the adjusting screw (s_1). After you have set the valve, lock the adjusting screw with the lock nut.



ATTENTION!

Only qualified personnel with mechanical skills may carry out any maintenance work. Generally, the only work that should ever be undertaken is to check, and possibly replace, the seals. When changing seals, oil or grease the new seals thoroughly before fitting them.

Seal kit NBR no. DS-324-N ¹⁾

Item	Qty.	Description
1	1	O-ring no. 119 Ø 23,47 x 2,62 N90
2	1	O-ring no. 116 Ø 18,72 x 2,62 N90
3	1	O-ring no. 114 Ø 15,54 x 2,62 N90
4	2	Backup ring Ø 17,10 x 2,00 x 1,40 FI0751
5	2	Backup ring Ø 15,30 x 2,00 x 1,40 FI0751



IMPORTANT!

¹⁾ Seal kit with FKM (Viton) seals, no. DS-324-V

7 Ordering code

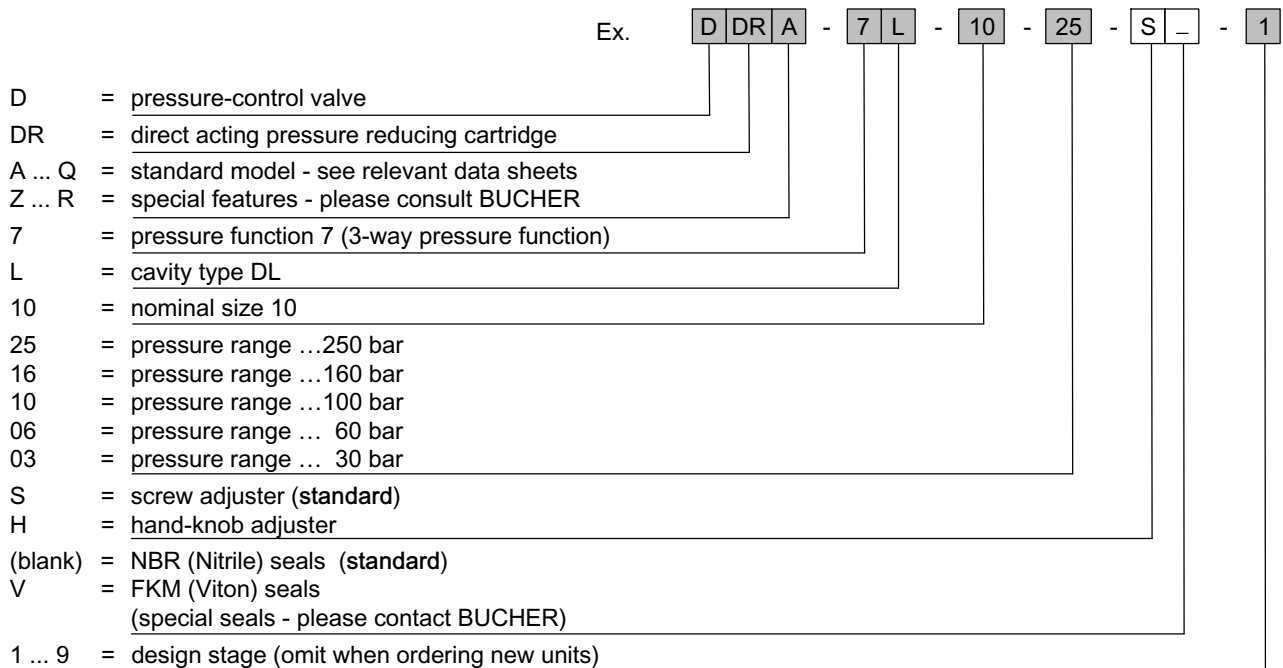

8 Related data sheets

Reference	(Old no.)	Description
400-P-040011	(i-32)	The form-tool hire programme
400-P-060201		Cavity type DL
400-P-317101		Sandwich pressure-reducing valve, size 6, type SDDRA-7L...-6...
400-P-326101		Sandwich pressure-reducing valve, size 10, type SDDRA-7L...-10...
400-P-740121		Line-mounting body, type GCLA (G 3/4")
400-P-740122		Line-mounting body, type GCLAA (G 3/4")

info.ch@bucherhydraulics.com

www.bucherhydraulics.com

© 2019 by Bucher Hydraulics AG Frutigen, CH-3714 Frutigen

All rights reserved.

Data is provided for the purpose of product description only, and must not be construed as warranted characteristics in the legal sense. The information does not relieve users from the duty of conducting their own evaluations and tests. Because the products are subject to continual improvement, we reserve the right to amend the product specifications contained in this catalogue.

Classification: 430.305.305.320.355